

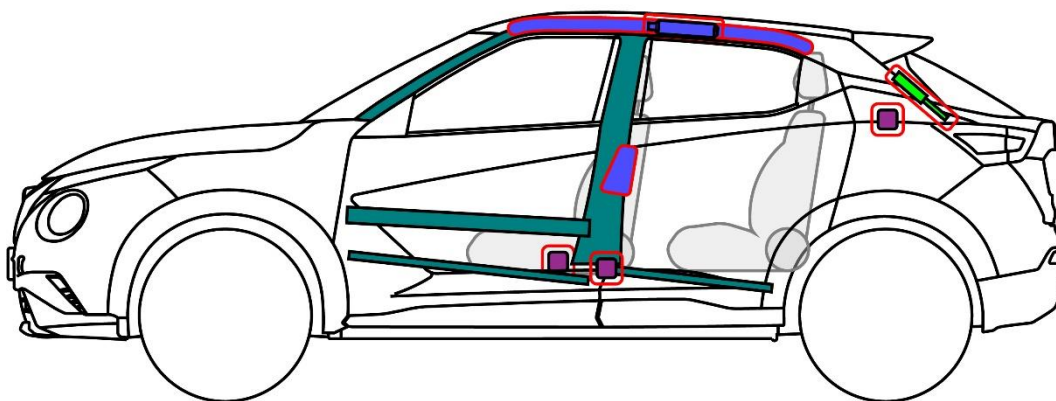

NISSAN

# Juke

TIP: F16, 5 vrata SUV  
(2019 -)

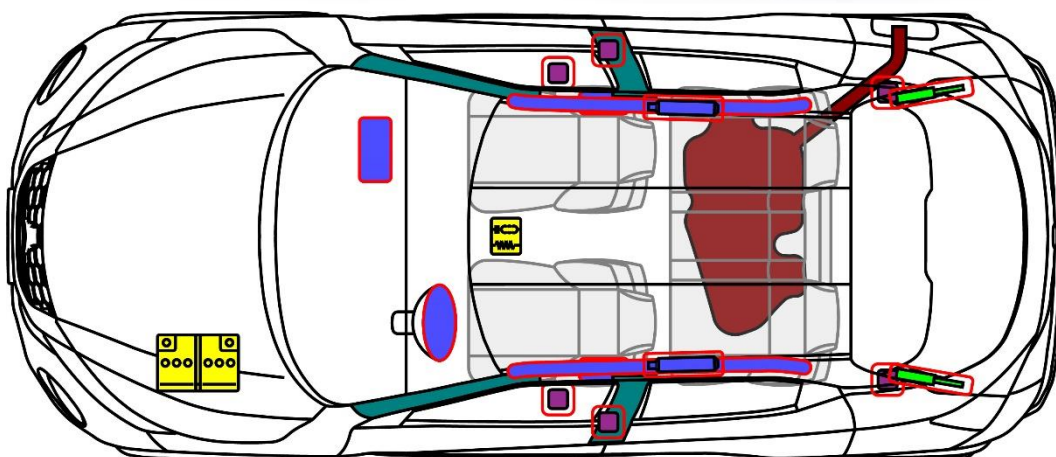

	Zračni jastuk		Plinski generator		Zatezač sigurnosnog pojasa		SRS upravljački uređaj		Aktivni sustav za zaštitu pješaka
	Automatski sustav zaštite od prevrtanja		Plinsko-hidraulični podupirač / zategnuta opruga		Područje visoke otpornosti		Područje koje zahtijeva posebnu pozornost		
	Niskonaponski akumulator		Niskonaponski ultrakondenzator		Spremnik za gorivo		Spremnik za plin		Sigurnosni ventil
	Visokonaponski akumulatorski paket		Visokonaponski električni kabel		Visokonaponski uređaj koji isključuje visoki napon		Kutija s osiguračima za isključivanje visokog napona		Visokonaponski ultrakondenzator
	Spremnik za benzin/etanol								

## 1. Identifikacija

Model



Poklopac goriva



Marka



## 2. Imobilizacija / stabilizacija / dizanje

Immobilizirajte vozilo:

1. Blokirate kotače
2. Za automatski mjenjač odaberite položaj P (parkiranje)
3. Postavite parkirnu kočnicu
4. Pritisnite tipku start/stop



Točke podizanja:

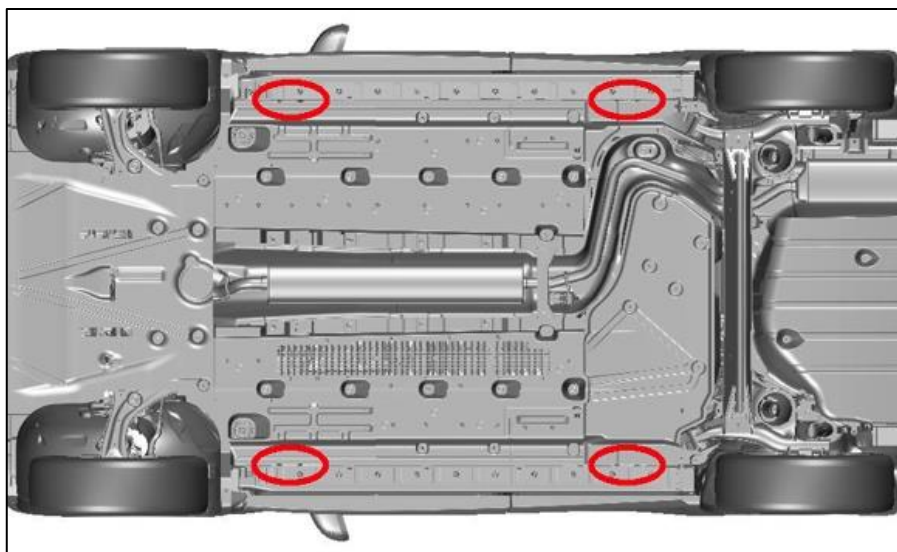

### 3. Sigurnosni propisi / izključivanje opasnosti

Pristup motornom prostoru



Odspojite bateriju od 12 volti

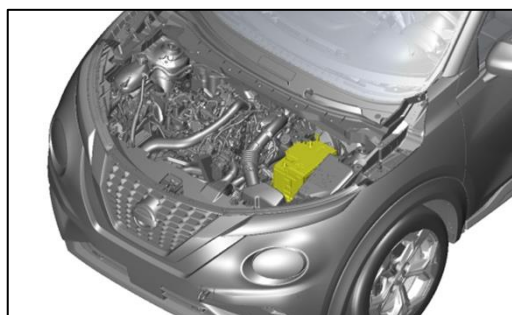
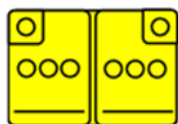

1. Isključite kontakt
2. Odspojite negativni priključak (-)
3. Odspojite pozitivnu stezaljku (+)



UVIJEK NOSIMO PRIMJERENU OSOBNU ZAŠTITNU OPREMU (OZO).

### 4. Pristup putnicima

Čelik visoke čvrstoće u tijelu

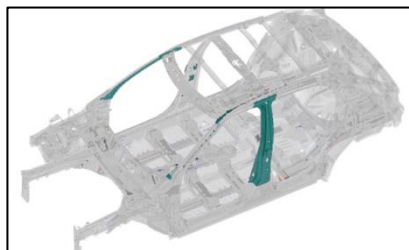

Čelik visoke čvrstoće na vratima

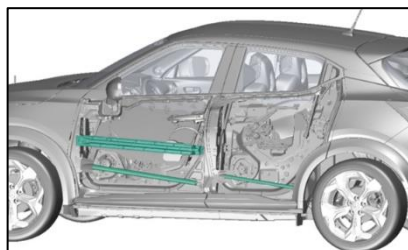

Podešavanje stupa upravljača



Podešavanje sjedala











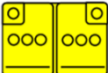

**Vrste stakla:**

- A. Laminirano staklo.
- B. Kaljeno staklo.



**5. Spremljena energija / tekućine / plinovi / kruta goriva**

	12V	 
	R-1234yf 450 ±25 g	   
	46 L	 

**6. U slučaju požarav**



**KORISTITE VODU**



**PLINSKI OBLOG, RIZIK OD RAZNOG UČINKA**

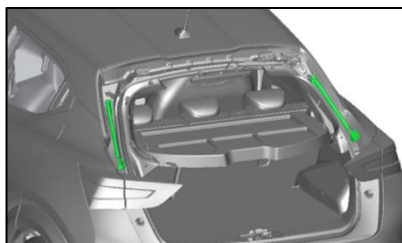

**8. Transport / skladištenje / odvuci**

Pohrana kuke za oporavak



Mjesto prednja kuka













Mjesto stražnje kuke



Vuča



**10. Objašnjenje piktograma**

	Opći znak upozorenja		Zapaljivo
	Upozorenje, niska temperatura		Opasno za ljudsko zdravlje
	Komponenta klima-uređaja		Eksploziv
	Vozilo na gorivo skupine tekućina 2		Korozivna tvar
	Poklopac motora		Uporaba vode prilikom gašenja požara